



Online Battery Backup



UPS-17602-52R – 6000 VA UPS

User Manual

AMETEK®

ELECTRONIC SYSTEMS PROTECTION

ADVANCED SERIES MODE®	EMPOWER®	INRUSH CURRENT ELIMINATION®	SERIES MODE®
AXESS®	ENERGY INTELLIGENCE®	MULTIPAK®	SURGE ELIMINATION®
COUVS®	ENVISION®	MULTI-STAGE®	SURGEX®
DEFENDER SERIES®	ESP®	NEXT GEN®	SURGEXICE®
DIGITAL QC®	FLATPAK™	PCS™	
ECOMMANDCENTER®	ICE®	POWERFRAME®	
ELIMINATOR SERIES™	IMPEDANCE TOLERANT™	REMOTE PORTAL®	

This product may be covered by one or more claims of the following patents or published patent application:

U.S. Patent Nos.: RE39,466; 2,461,332; 4,870,528; 4,870,534; 5,136,455; 6,040,969; 6,728,089; 6,744,613; 6,947,266; 7,068,487; 7,184,252; 7,511,934; 7,541,696; and 7,551,412; 8,482,885; 8,520,349; 8,547,672; 8,614,866; 9,166,396; 9,225,534; 9,310,870; 10,014,680; 10,090,622; 10,114,395

U.S. Patent Application Publication Nos.: 2012/0221161; 2013/0073232

Canadian Patent Nos.: 1,332,439; 1,333,191; 2,461,332 and 2,511,695

Table of Contents

1. Introduction	1
1-1. FCC Compliance	1
1-2. Safety	1
1-2-1. Safety Intended Use	1
1-2-2. Safety Notices	2
1-3. Emergency	3
1-4. Leakage Currents	3
1-5. Radio Interference	3
1-6. Batteries	3
1-7. Repackaging	4
1-8. About the Operating Instructions	4
1-9. Symbols	5
1-10. Documentation Structure	5
1-11. Preparation for Use	5
1-11-1. Delivery	5
1-11-2. Storage	5
1-12. Unpacking and Inspection	5
1-13. Handling	6
1-14. Environmental Conditions	6
1-15. Access to Area	6
1-16. Rack Loading	6
2. Rack/Tower Installation	7
2-1. Tower Installation	7
2-2. Rack Installation	8
2-2-1. Attaching the mounting ears	8
2-2-2. Mechanical Fixing of 19-inch Units	8
2-2-3. Assembly Steps	9
2-3. Electrical Preparations for UPS Installation	11
2.3.1. External Protection and Isolating Devices	11
2.3.2. Installation Data	11
2.3.3. Cable sizes and Current	12
2.3.4. Connection Warnings	12
2-4. Connecting Mains and Load Cables	14
2.4.1. Prepare input and output cables	14
2.4.2. Connect the input and output cables to the terminal block	14
3. Operations	16
3-1. Operating Mode / Status Description	16
3-2. Button Operation	17
3-3. LED Indicators	18
3-4. Audible Alarm	18
3-5. Single UPS Operation	18
3-5-1. Turn on the UPS with utility power supply (to Line mode)	18
3-5-2. Turn on the UPS without utility power supply (to Battery mode)	19
3-5-3. Connect devices to the UPS	19

3-5-4. Charge the batteries.....	19
3-5-5. Battery mode operation.....	20
3-5-6. Test the batteries.....	20
3-5-7. Turn off the UPS with utility power supply in Line mode.....	20
3-5-8. Turn off the UPS without utility power supply in Battery mode.....	21
3.6. LCD Operation.....	22
3-6-1. Main Interface (Home Page).....	23
3-6-2. Operation Menu.....	23
4. Interfaces	33
4-1. Serial Interface COM3.....	33
4-2. Interface Slot COM.....	33
5. Emergency Power Off (EPO)	34
6. Maintenance	35
6-1. Maintenance Warnings.....	35
6-2. Test, Replacement and Disposal of Batteries.....	35
6-2-1. Battery Replacement.....	35
6-3. Storage.....	37
6-4. Cleaning.....	37
7. Troubleshooting	38
7-1. Warning status.....	38
7-2. Fault Mode.....	38
7-3. Troubleshooting Table.....	38
9. Appendix A : Specifications	42

1. Introduction

Thank you for selecting this uninterruptible power supply (UPS). SURGEX's Rackmount UPS offers the most reliable protection from the harmful effects of electrical line disturbances for your computing and communications equipment. SURGEX's ISO 9001 certification represents our commitment to building world-class products. We take pride in every unit that leaves our facility.

1-1. FCC Compliance



ATTENTION: Changes or modifications to this unit not expressly approved by the party responsible or in FCC compliance could void the user's authority to operate the equipment.

This equipment was tested and complies with the limits for a Class A digital device, pursuant to Part 15 of FCC Rules. These limits are designed to provide reasonable protection against harmful Interference when the UPS is operating in a commercial environment. The UPS generates, uses, and can radiate radio frequency energy. If installation and use is not in accordance with the instruction manual, it may cause harmful interference to radio communications.



ATTENTION: Operation of this equipment in a residential area may cause harmful radio communications interference. The user is responsible for correcting the interference.

1-2. Safety

1-2-1. Safety Intended Use

This device serves as an uninterruptible power supply for connected loads. The device is in compliance with all relevant safety regulations concerning information technology equipment, including electronic machines for use in an office environment.

Depending on the type and rating of UPS device, certain configurations of battery extensions must be connected. These battery extensions may only be connected to the compatible basic UPS unit.

This system, henceforward the "unit", serves as uninterruptible power supply for connected loads, available for use in 19-inch racks. The 6kVA must be operated with at least one rack mounted battery extension. These battery extensions may only be connected electrically with the corresponding base UPS unit.



WARNING: SURGEX considers the safety of personnel to be of paramount importance. For this reason, it is essential that procedures relating to safety be studied before commencing work, and properly adhered to thereafter.

- The **User or Operator** may intervene in the operation of the UPS provided that the instructions laid out in “Batteries” on page 3 and “Button Operation” on page 17 are adhered to.
- The “**Installation**” of the UPS, described in “Electrical Preparations for UPS Installation” on page 11, may only be carried out by **qualified technical personnel**.
- Even when all switches and interrupters are open, hazardous voltages are present within the UPS; any operation that requires protection panels to be opened and/or removed must be carried out by **SURGEX authorized technical personnel only**.
- The UPS listed in Table 1 on page 4, with a mounting height of 3 U (1 U = 1.75” (44.45 mm)), is designed for horizontal installation in 19-inch racks of Industrial strength.

1-2-2. Safety Notices



WARNING: Carefully read the following safety notices! Failure to observe the instructions may endanger your life, your health, the reliability of your device or the security of your data.

- Transport the unit only in suitable packaging (protected against jolts and shocks).
- If the equipment is moved from a cold environment to the operating room, condensation may occur. Before you switch on the equipment it must be absolutely dry. An acclimatization period of at least two hours is required.
- The equipment must be installed in accordance with the environmental conditions specified in “Environmental Conditions” on page 6 and in Table 4 on page 11 . Install the UPS indoors, and in a structurally sound area.
- Even with all buttons in “OFF” (see “Button Operation” on page 17) the device (UPS) is **not** isolated from the mains. To isolate completely from the mains, the power cables must be disconnected.
- Lay all cables so that nobody can stand on them or trip over them. When connecting the device to the power supply, follow instructions in the section “Electrical Preparations for UPS Installation” on page 11.
- Make sure that no objects (e.g. pins, necklaces, paper clips, etc.) fall inside the device.
- In emergencies (e.g. damaged case, controls or power cables, penetration of liquids or foreign matter) switch off the device and contact the appropriate customer service representative.
- Do not connect equipment that will overload the UPS (e.g. laser printers or vacuum cleaners) or demand DC-current (e.g. half-wave rectifiers).
- When cleaning the unit, follow the instructions in the chapter “Maintenance” on page 35.
- The sum of the leakage currents (protective conductor current) of the UPS and the connected devices may exceed 3.5 mA for ratings of the UPS. Earth connection is essential before connecting supply. Connect your UPS power module’s grounding terminal to a grounding electrode conductor.
- Data transmission lines should **not** be connected or disconnected during a thunderstorm.

- The UPS is connected to a DC energy source (battery). The output terminals may be live when the UPS is not connected to an AC supply.
- Emergency Power Off (EPO) input is located on the rear of the unit (see Figure 11 on page 13). When this connection is open, the logic circuit will immediately shut down the UPS output.
- When mounting the unit in a rack, it has to be hooked on both sides and the front plate of the unit has to be fixed to the rack by screws. The unit has to be fixed in a horizontal position.
- Do not install the UPS near magnetic storage media, as this may result in data corruption.
- The vents for air intake and outlet at the front and rear side must not be obstructed. Leave adequate space around all sides of the UPS for proper ventilation.
- Do not mount the unit with its front or rear panel facing down (at any angle). Mounting in this manner will seriously inhibit the units internal cooling, eventually causing product damage not covered by warranty.

1-3. Emergency



WARNING: The supply to the load may be operated by opening all the switches.



WARNING: DO NOT USE WATER to extinguish any fires that may occur in the area in which the UPS is installed.

1-4. Leakage Currents



WARNING: Connect the earth ground [protection earth (PE)] safety conductor before any other cables are connected.

1-5. Radio Interference

The SurgeX UPS is a class A product. The UPS device may cause radio interference. Do not place it near devices which are especially susceptible to electromagnetic interference (e.g. transmitters/receivers, radar, metal detectors, anti-theft devices).

1-6. Batteries

Battery maintenance must be carried out by authorized personnel.

- The batteries installed in external battery cabinets may contain electrolyte. Under normal conditions the containers are dry. A damaged battery may leak electrolyte which can be dangerous in contact with skin and cause irritation to the eyes. Should this happen, wash the affected part with copious amounts of water and seek immediate medical advice.
- Voltage is always present on the battery contacts.
- Even when discharged a battery has a capacity to supply a high short circuit current, which, in addition to causing damage to the battery itself and to associated cables, may expose the operator to the risk of burns.

-
- The voltage of a single cell of a single battery block is not dangerous. However, a number of cells or battery blocks, connected in series, can produce hazardous voltages.
 - The battery is a “hermetic” type battery and must not be kept in storage or disuse for periods exceeding 6 months at 68°F (20°C) without being recharged (having been charged to 100% at the beginning of any such period). If this period is exceeded it is essential that the batteries be recharged, which requires that the UPS be switched on. If these conditions are not respected the performance of the battery can no longer be guaranteed. We advise recharging the batteries at least once every 4 months.
 - Since new batteries often do not provide full capacity after an initial charge it may be necessary to carry out a number of discharge/recharge cycles before optimum performance is achieved.
 - In order to protect the environment batteries must be disposed of in accordance with the regulations governing disposal of toxic and harmful waste.

1-7. Repackaging

To re-pack, proceed as follows:

1. Do not pack the equipment until at least six hours have elapsed since the last recharge.
2. Place the equipment in bags made of a material sufficiently porous to allow it to breath (e.g. 100µm polyethylene).
3. Do not remove air from the packaging.

1-8. About the Operating Instructions

This manual contains information regarding the installation, operation and use of the Uninterruptible Power Supply (UPS). It is advised that this instruction manual be consulted before installation of the equipment, which operation shall only be carried out by qualified personnel. Thereafter, it shall be kept and referred to whenever it is necessary to carry out work on the UPS.

1-9. Symbols

The following symbols are used in this handbook:



WARNING: indicates instructions which, if not observed, may endanger your life, your health, the reliability of your device or the security of your data.

NOTE: Indicates additional information and tips.

1-10. Documentation Structure

These instructions can be supplemented with additional sheets, describing, for example, specific extensions, options or device status.

1-11. Preparation for Use

1-11-1. Delivery

The goods have been checked thoroughly before dispatch. On receipt check the packaging and ensure that the contents are undamaged.

1-11-2. Storage

If it is not intended that the UPS be used immediately upon delivery, attention shall be paid to the storage conditions.

If the batteries or the equipment is to be stored, they must be kept clean, in a dry environment and away from extremes of temperature.

Table 2: Storage Data

Temperature limits - Batteries ONLY	+32°F to +104°F (0°C to +40°C)
Temperature limits - UPS without batteries	-13°F to +131°F (-25°C to +55°C)
Relative humidity	from 10% to 90%

1-12. Unpacking and Inspection

The utmost care shall be taken when removing the packaging in order to avoid damaging the equipment. Check all packaging materials to ensure that no items are discarded.



WARNING: A battery cabinet is very heavy. The unit weight of a battery cabinet is 142 lbs. (64.5kg). To prevent personal injury or damage to the battery cabinet suitable lifting equipment and multiple people should be employed when lifting the battery cabinet.

Unpack the package and check the package contents. The shipping package contains:

UPS Shipping Package	Battery Shipping Package
<ol style="list-style-type: none"> 1. One UPS 2. One user manual 3. Rail kit 4. One USB cable 5. Two sets of tower stands consisting of two feet, two short and four long extensions 6. One parallel cable and one current share cable (units with parallel option only) 7. Two Mounting ears 8. Ferrules 	<ol style="list-style-type: none"> 1. One Battery cabinet 2. One Battery cable 3. Two Mounting ears 4. Rail kit 5. Two sets of tower stands consisting of two feet and two short extensions

NOTE: Before installation, please inspect the unit. Be sure that the unit is not damaged during transportation. Do not turn on the unit and notify the carrier and dealer immediately if there is any damage or lacking of some parts. Please keep the original package in a safe place for future use.

1-13. Handling

The equipment must be kept upright at all times and handled with care, damage may be caused if dropped or subjected to severe impact.

1-14. Environmental Conditions

The UPS must be installed in an area protected from extremes of temperature, water and humidity and the presence of conductive powder or dust. (See Table 4 on page 11). Do not stack units and do not place any objects on top of a unit.

The functional temperature range of the UPS is 32°F to 104°F (0°C to 40°C).

The ideal ambient temperature range is 59°F to 77°F (15°C to 25°C). The maximum ambient operating temperature is 104°F (40°C).

The battery life is defined at 68°F (20°C). Operation of the equipment above 77°F (25°C) reduces the service life of the batteries dramatically.

1-15. Access to area

The area must have sufficient space for the installation operation to be carried out. Access doors must be sufficiently large to permit passage of the unit .

1-16. Rack Loading

Taking into consideration the weight of the UPS/batteries as reported in the mechanical specifications for the battery cabinet on page 48, it is necessary that the chosen cabinet be capable of supporting the weight of the unit/batteries.

2. Rack/Tower Installation

2-1. Tower Installation

The UPS system ships with two sets of feet and 6 extensions (2 short extensions plus 4 long extensions) that can be used to install the UPS module in the Tower configuration.

A. Install Stand-a-lone. Refer to Figure 1.

Assemble two feet and one short extension as one tower stand as shown in Step 1.

Align the two stands approximately 35 cm apart as shown in Step 2.

Put the UPS module in the stands as shown in Step 3.

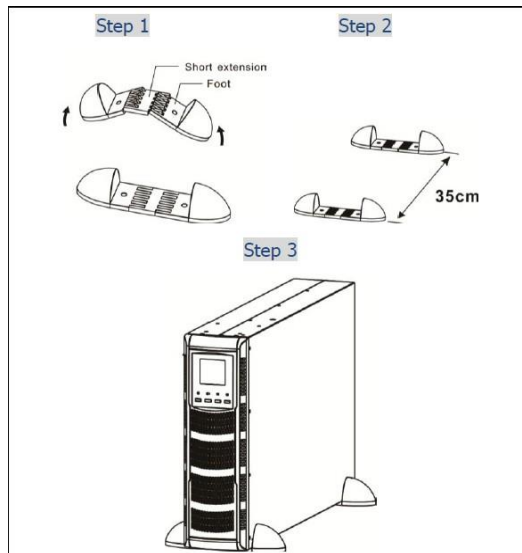

Figure 1

B. Install UPS module and one battery bank as shown in Figure 2 below.

Assemble two feet and two long extensions as one tower stand as shown in Step 1.

Align the two stands approximately 35 cm apart as shown in Step 2.

Put the UPS module and battery bank in the stands as shown in Step 3.

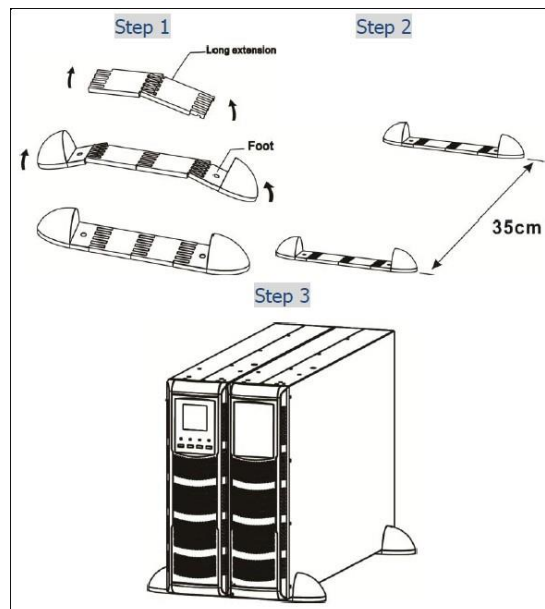

Figure 2

2-2. Rack Installation

2-2-1. Attaching the Mounting Ears

Attach the mounting ears to the side mounting holes of UPS or the battery bank using the screws provided. The ears should be oriented as shown in Figure 3 below.

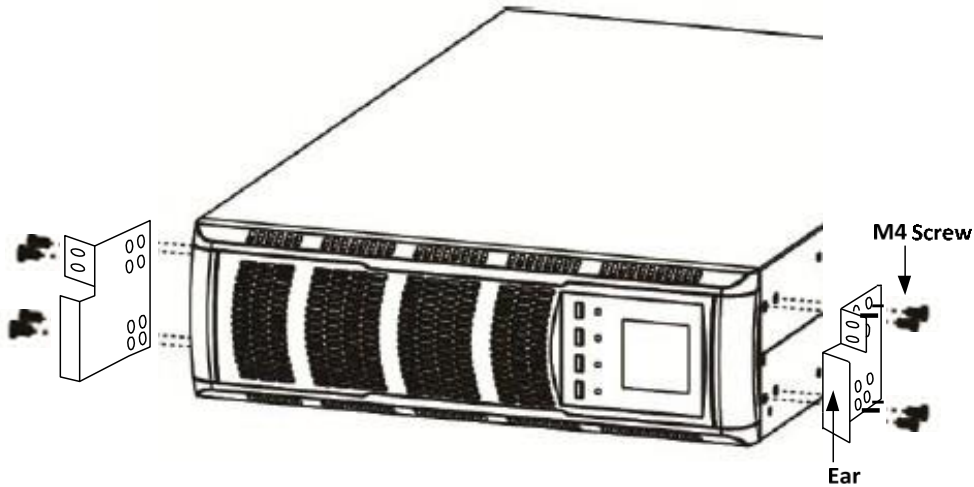

Figure 3

2-2-2. Mechanical Fixing of 19-inch Units

Selection of the mounting location

NOTE: The UPS and its battery cabinets are designed to be mounted horizontally in 19-racks. When installing the units, please consider the weight, especially of the battery extension. Preferably the units should be installed in the lower section of the rack. UPS systems consisting of several units must be installed so that the battery extensions are mounted in the lower section of the rack with the UPS directly above.

Included in each Rackmount carton is a rail kit. The Rail Kit consists of the following components (refer to Figure 4):

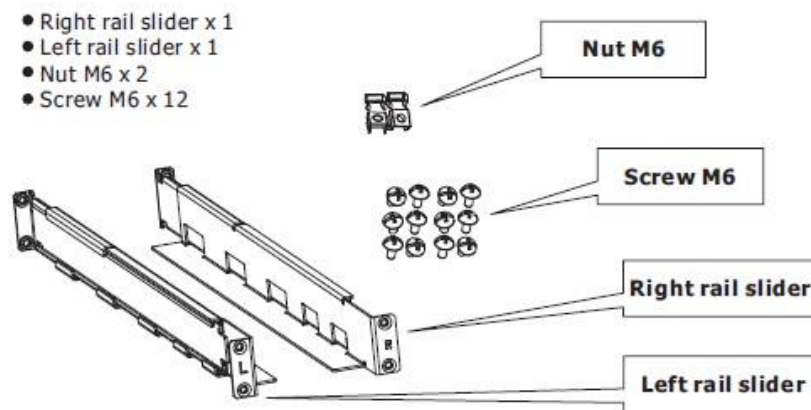

Figure 4

2-2-3. Assembly Steps

Step 1: Use 4 M6 screws to mount the right and left rail sliders to the two front posts of the four-post rack. Refer to Figure 5 below.

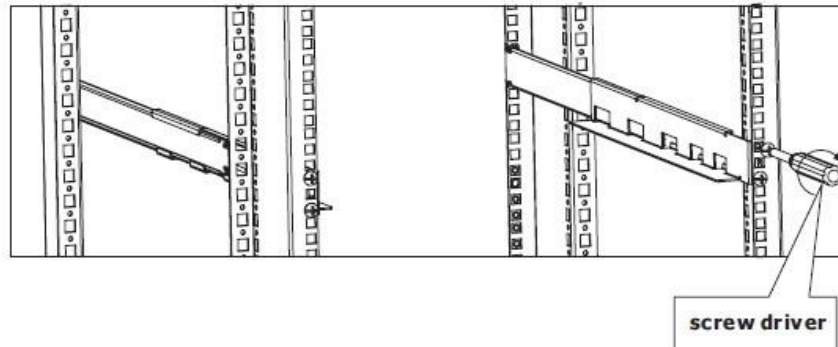

Figure 5

Step 2: Use 4 M6 screws to mount the right and left rail sliders to the two back posts of the four-post rack. Refer to Figure 6 below.

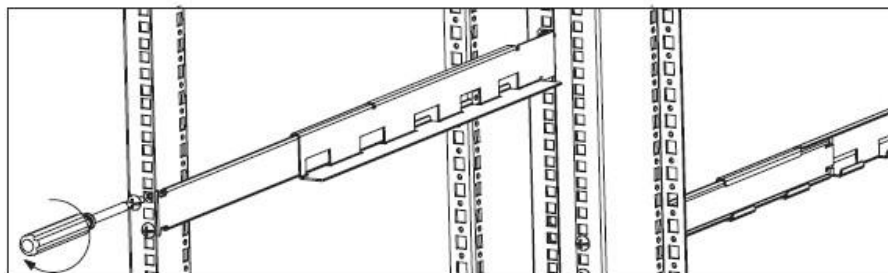

Figure 6

Step 3: Insert one M6 nut into the right and left front posts of the four-post rack for a 3U installation. Refer to Figure 7 below.

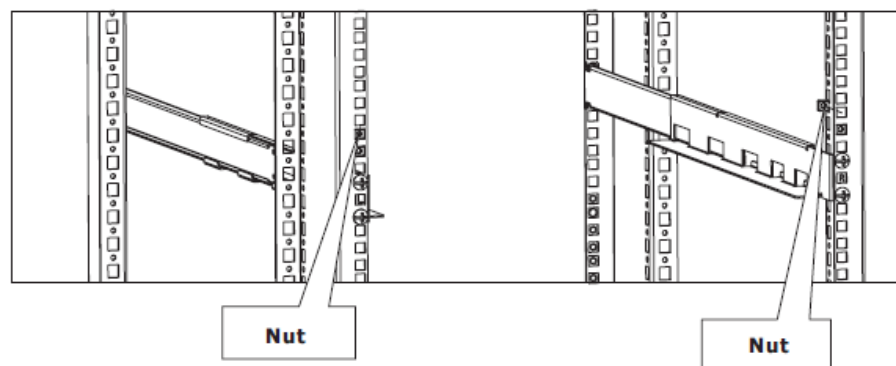

Figure 7

Step 4: Slide the UPS with its right and left ears attached onto the rail guide until the ears are in contact with the front of the rail guide. Refer to Figure 8 below.

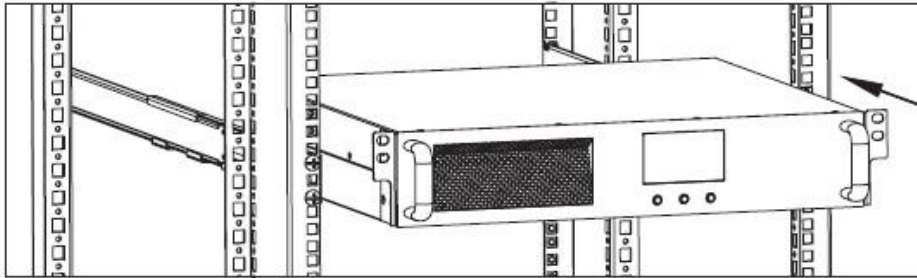

Figure 8

Step 5: Fasten each ear to the rack with the M6 screws. Refer to Figure 9 below.

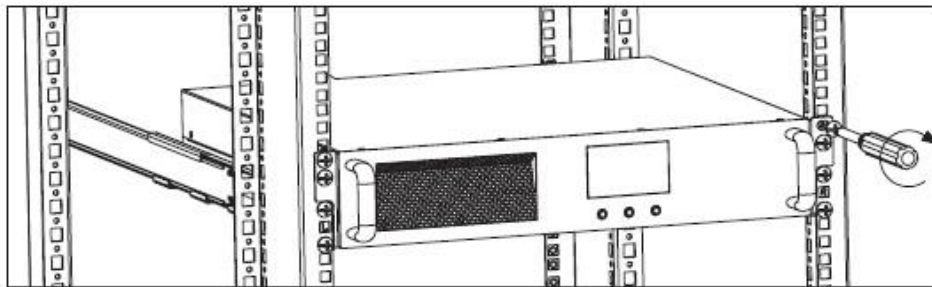

Figure 9

Step 6: Assembly complete.

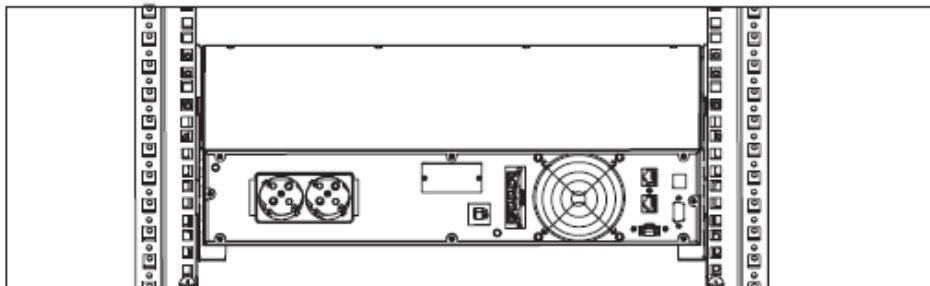

Figure 10

When the unit is securely in the rack continue with the electrical installation. See “Electrical Preparations for UPS Installation” on page 11.

2-3. Electrical Preparations for UPS Installation

Installation and wiring must be performed in accordance with the local electric laws/regulations by authorized technical personnel only.

Make sure the mains wire and breakers in the building are enough for the rated capacity of UPS to avoid the hazards of electric shock or fire.

NOTE: Do not use the wall receptacle as the input power source for the UPS, as its rated current is less than the UPS's maximum input current. Otherwise the receptacle may be burned and destroyed.

Switch off the mains switch in the building before installation.

Turn off all the connected devices before connecting to the UPS.

2-3-1. External Protection and Isolating Devices



WARNING: A disconnect switch shall be provided by others for the AC input circuit. To reduce the risk of fire, connect only to a circuit provided with branch circuit over current protection for Table 3 Amperes rating in accordance with the National Electric Code, ANSINFPA 70.

The following table indicates the protection devices (circuit breakers and fuses) which must be installed by the installing personnel for protection of both the cables and the equipment. One external branch breaker on the UPS output side is strongly recommended for over-current protection and for easy disconnecting the load device.

Table 3: Fuses or circuit breakers

UPS Part Number		UPS-17602-52R
INPUT	Fuse	50A
	Circuit Breaker	50A

2-3-2. Installation Data

Table 4: Environment Data

Ambient temperature	+32°F to +104°F (0°C to +40°C)
Relative humidity (w/o condensing at 20°C)	90%
Max. altitude (w/o de-rating)	1000 m a.s.l
Cable inlet	Bottom at the rear side
Air inlet	front
Air outlet	rear

2-3-3. Cable Sizes and Current

The following table indicates the recommended sizes of conductors in accordance with the NEC®. (air temperature surrounding the conduits not greater than 104°F (40°C).)

NOTE: Cable sizes are suggested and based on standard configurations. Installed input/output wiring for the UPS should be able to withstand over 40 amps of current. Installers should verify correct conductor sizes and temperature ratings pursuant to NEC® and/or state or local codes. If the installation requires long conductor runs, consult NEC® and/or state or local codes to account for electrical losses.

Table 5					
	Term ID	Description	UPS Part Number		
			UPS-17602-52R		
			Wire gauge (awg)	Term torque (in - lbs.)	min wire temp (°C)
Input Mains	L	Input Line	6	10	70
	N	Input Neutral	6	10	70
	GND	Input Ground	6	10	70
Output	L	Output Line	6	10	70
	N	Output Neutral	6	10	70
	GND	Output Ground	6	10	70

2-3-4. Connection Warnings



WARNING: Carefully read the following safety notices!

- There is feedback protection inside.
- The UPS should be connected with TN earthing system.
- The power supply for this unit must be single-phase rated in accordance with the equipment nameplate. It must also be suitably grounded.
- Use of this equipment in life support applications where failure of this equipment can reasonably be expected to cause failure of the life support equipment or to significantly affect its safety or effectiveness is not recommended. Do not use this equipment in the presence of a flammable anesthetic mixture with air, oxygen, or nitrous oxide.

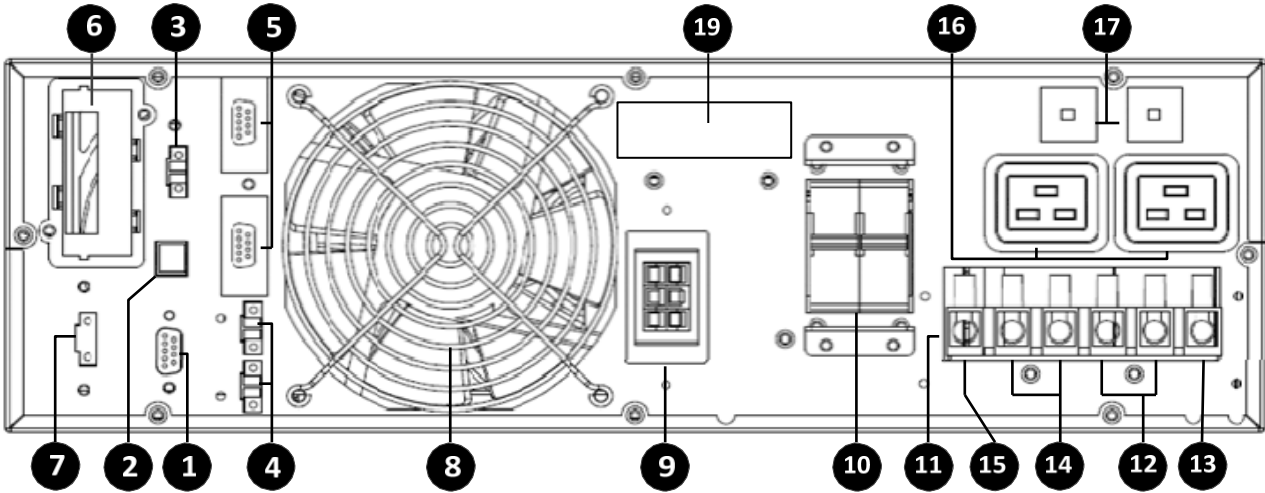

Figure 11: UPS Rear Panel View

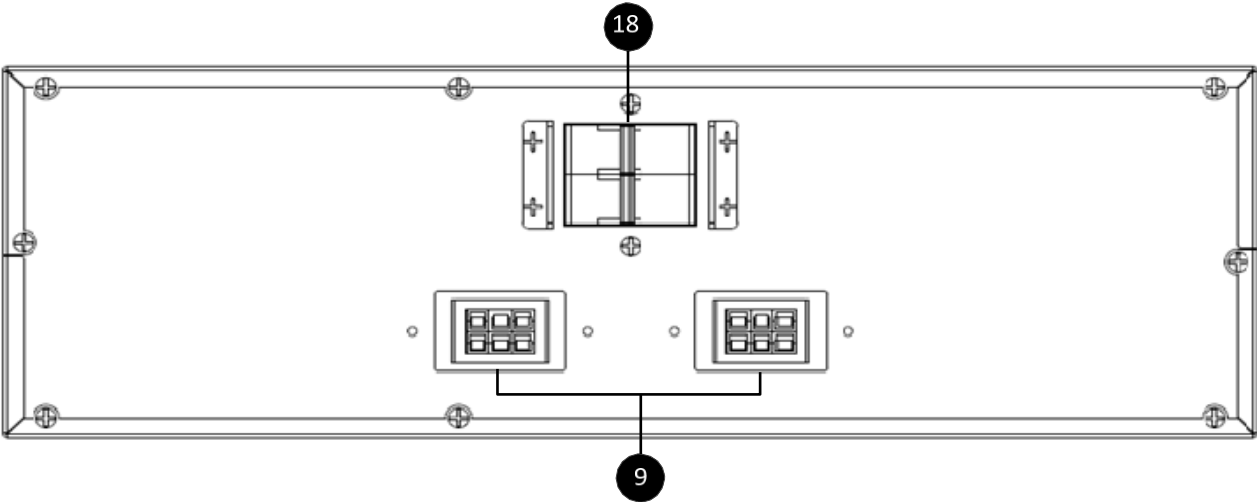

Figure 12: Battery Rear Panel

Legend

- | | |
|--|---|
| 1. RS-232 communication port | 11. Input/output terminal block |
| 2. USB communication port | 12. Input terminals |
| 3. EPO (Emergency Power Off) connector | 13. Input ground terminal |
| 4. Share current port (for parallel function) | 14. Output terminals |
| 5. Parallel port (for parallel function) | 15. Output ground terminal |
| 6. Intelligent slot | 16. IEC 320-C19 output receptacles |
| 7. EMBS (External Maintain Bypass Switch) port | 17. 16A Output circuit breakers |
| 8. Cooling fan | 18. Battery pack output circuit breaker |
| 9. External battery connector | 19. Part number and serial number label |
| 10. Input circuit breaker | |

2-4. Connecting Mains and Load Cables

Installation and wiring must be performed in accordance with the local electric laws/regulations and execute the following instructions by professional personnel.

Make sure the mains wire and breakers in the building are enough for the rated capacity of UPS to avoid the hazards of electric shock or fire.

NOTE: Do not use the wall receptacle as the input power source for the UPS, as its rated current is less than the UPS's maximum input current. Otherwise the receptacle may be burned and destroyed.

Switch off the mains switch in the building before installation.

Turn off all the connected devices before connecting to the UPS.

2-4-1 Prepare input and output cables

Prepare the input and output cables as described in Table 5 on page 12 and as shown in the figure below.

The selections for color of wires should be followed by the local electrical laws and regulations.

Remove 5/8" length of insulation from each of the conductors and terminate each conductor with a ferrule.

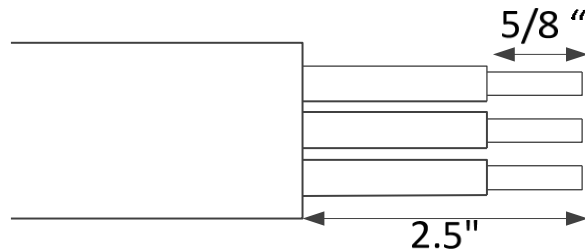

2-4-2 Connect the input and output cables to the terminal block

Remove the cover from the terminal block housing located on the rear panel of UPS. Then connect the wires as shown in figure 13 on page 15 (Refer to Table 5 on page 12 and to Figure 11 on page 13). It is suggested that the input and output cables to the UPS be housed in earthed, metal conduits suitable for the wire box cover opening (1.375 inches).

After connecting the wires and strain relief reattach the cover to the terminal block housing.

NOTE: Make sure that the wires are connected tightly to the terminals. Refer to Table 5 on page 12.

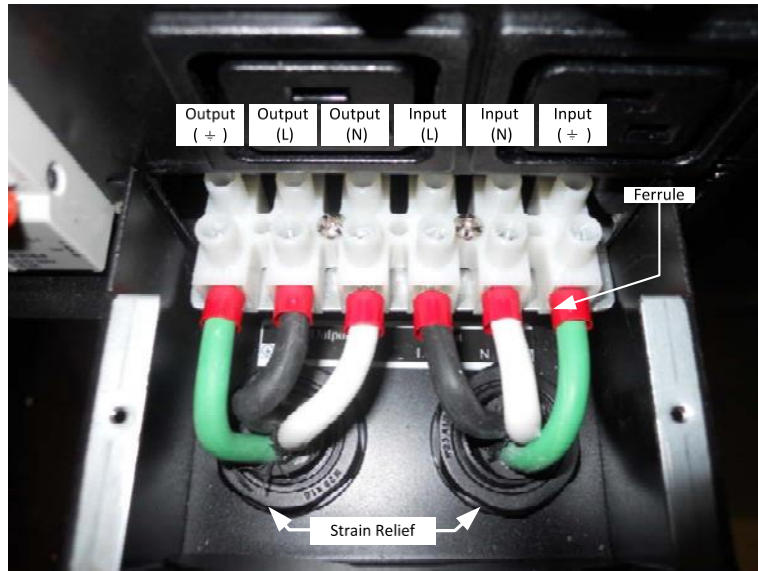

Figure 13. Input, Output and Ground connections to the UPS (shown with strain relief)

 **Warning:**

- Make sure the UPS is not turned on before installation. The UPS should not be turned on during wiring connection.
- Do not try to modify the standard model to the long-run model. Particularly, do not try to connect the standard battery cabinet to a non-standard external battery. The battery type and voltage may be different. If you connect them together, it may lead to increased risk of electric shock or fire!

 **Warning:**

- For standard battery pack, there is one DC breaker to disconnect the battery pack and the UPS. But for other external battery pack, make sure a DC breaker or other protection device between UPS and external battery pack is installed. If not, please install it carefully. Switch off the battery breaker before installation.

NOTE: Set the battery pack breaker in “OFF” position and then install the battery pack.

- Pay attention to the rated battery voltage marked on the rear panel. If you want to change the numbers of the battery pack, please make sure you modify the setting simultaneously. The connection with wrong battery voltage may cause permanent damage of the UPS. Make sure the voltage of the battery pack is correct.
- Pay attention to the polarity marking on external battery terminal block, and make sure the correct battery polarity is connected. Wrong connection may cause permanent damage of the UPS.

3. OPERATIONS

3-1. Operating Mode/Status Description

Mode/Status	Description
UPS Power On	When UPS is powered on, it will enter into this mode for a few seconds for initializing the system.
AC Mode	When the input voltage is within acceptable range, and the UPS is turned on (the inverter is running), the UPS will provide pure and stable sine wave AC voltage. The UPS will also charge the battery in AC mode.
Converter Mode	When input frequency is within 46 to 64Hz, the UPS can be set with a constant output frequency (50 Hz or 60Hz) through the inverter. The UPS will still charge battery at this mode. There is no bypass at this mode.
Battery Mode	When the input voltage is out of the acceptable range or power failure, and the UPS is turned on (the inverter is running), the UPS will backup power from battery.
Bypass Mode	When input voltage is within acceptable range and the bypass is enabled, and the UPS (inverter) is not turned on or the inverter can't support the load, the UPS will supply power to the load through bypass.
Battery Test Mode	When the UPS is in AC mode or Converter mode, and the battery test command is enabled through LCD or monitoring software, the UPS will start Battery test. This operation is used to check the battery status.
Warning Status	If some error occurs in the UPS (but is still running normally), the buzzer will alarm and warning code will appear in the LCD for troubleshooting.
Fault Mode	When fatal error occurs in the UPS, it will beep continuously and go to fault mode. It will display fault codes in LCD.

3-2. Button Operation

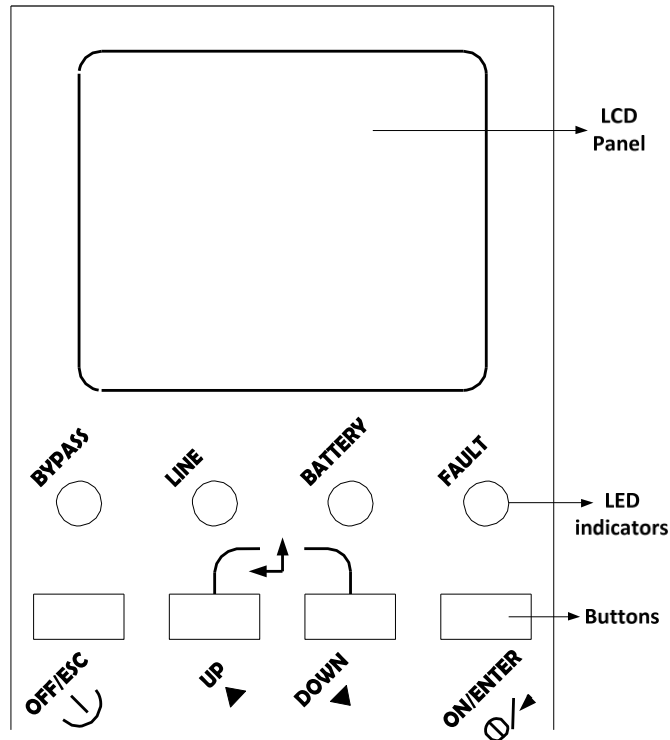

There are 4 buttons on the front panel,

Button	Function
ON/ENTER	Press this button to turn on the UPS. Or press it to confirm the selection in the menu.
OFF/ESC	Press this button to turn off the UPS. Or press it to return to last menu.
UP	Press this button to jump up to an item in the menu. Or press this button to jump to the previous page in the screen. Or press this button to increase the number in the setting.
DOWN	Press this button to jump down to the next item in the menu. Or press this button to jump to next page in the screen. Or press this button to decrease the number in the setting.
UP + DOWN	To allow the LCD display to rotate 90° automatically, press these two buttons at the same time. This operation is used to configure the UPS in rack or tower display.

3-3. LED Indicators

There are 4 LEDs on front panel to show the UPS working status

Mode \ LED	Bypass	Line	Battery	Fault
UPS Power On	●	●	●	●
Bypass mode	●	○	○	○
AC Mode / Converter Mode	○	●	○	○
Battery mode	○	○	●	○
Fault mode	○	○	○	●
Battery test mode	○	●	●	○

Note: ● means LED is lit; ○ means LED is off; ● means LED is flashing.

3-4. Audible Alarm

UPS status	Buzzer status	Mute Control
Bypass mode	Beeping once every 2 minutes	Yes
Battery / Battery-test mode (normal battery voltage)	Beeping once every 4 seconds	Yes
Battery / Battery-test mode (low battery voltage)	Beeping once every second	Yes
Fault	Beeping continuously	Yes
Warnings (except overload)	Beeping once every second	No
Overload	Beeping twice every second	No

3-5. Single UPS Operation

3-5-1. Turn on the UPS with utility power supply (to Line mode)

- 1) Make sure mains input and battery are connected and that the battery pack breaker is in the “ON” position. Set the external mains input breaker to the “ON” position. The fan will now be running and the UPS will supply power to the loads via bypass. The UPS is operating in Bypass mode.

NOTE: When the UPS is in Bypass mode, the output voltage comes directly from the utility and the load is not protected by the UPS. To protect the load the UPS must be turned on to Line mode.

- 2) With the LCD on home page, press the “ON/ENTER” button. The LCD will show a prompt page of “Turn On”. Move the arrow to “Yes” using the up or down button and then press “ON/ENTER”. The UPS will start up and beep once. You could also enter the “control menu” to select the instruction “Turn On” to startup the UPS. Please refer to the section “LCD operation”.

- 3) A few seconds later the UPS will enter Line mode and “Line mode” will be displayed on the LCD.

NOTE: In line mode, if the utility power is abnormal, the UPS will transfer to Battery mode without interruption.

3-5-2. Turn on the UPS without utility power supply (to Battery mode)

- 1) Make sure the battery is connected and that the battery pack breaker is in the “ON” position.
- 2) Press the “ON/ENTER” button to start up the internal power. The UPS will enter into Bypass mode without output.
- 3) With the LCD on the home page, press the “ON/ENTER” button. The LCD will show a prompt page of “Turn On”. Move the arrow to “Yes” using the up or down button and then press “ON/ENTER”. The UPS will start up and beep once. You could also enter the “control menu” to select the instruction “Turn On” to startup the UPS. Please refer to the section “LCD operation”.
- 4) A few seconds later the UPS will enter into Battery mode and “Battery mode” will be displayed on the LCD.

NOTE: In battery mode the UPS will shut down automatically once the battery is depleted. If the utility power is restored the UPS will auto restart to Line mode.

3-5-3. Connect devices to the UPS

After the UPS is turned on devices (load) can now be connected to the UPS.

- 1) Turn on the UPS and then switch on the load devices one by one. The LCD panel will display the total load level.
- 2) At start up an inductive load can consume a large amount of power. If inductive loads, such as a printer, need to be connected, the inrush current should be calculated to ensure the capacity of the UPS is not exceeded.
- 3) If the UPS is overloaded the buzzer will beep twice every second.
- 4) When the UPS is overloaded shed some load immediately. For system safety, it is recommended that the total load connected to the UPS not exceed 80% of its nominal power capacity.
- 5) When the UPS is in Line mode, and the overload time exceeds the duration listed in the specification, the UPS will automatically transfer to Bypass mode. After the overload is removed the UPS will return to Line mode.
When the UPS is in battery mode, and the overload time exceeds the duration listed in the specification, the UPS will enter a fault status. At this time, if the bypass is enabled, the UPS will supply power to the load via bypass. If the bypass function is disabled, or the input power is not within the bypass acceptable range, the UPS will cutoff power to the load.

3-5-4. Charge the batteries

- 1) After the UPS is connected to the utility power the charger will automatically charge the batteries except when the UPS is in Battery mode or during a battery test.
- 2) It is recommended to charge the batteries for at least 10 hours before use otherwise the backup time may be shorter than expected.
- 3) Make sure that the battery numbers setting on the control board (Please refer to the section on changing battery quantity) is consistent with the actual number of batteries connected.

3-5-5. Battery mode operation

- 1) When the UPS is in Battery mode, the buzzer will beep according to the battery capacity. Normally, the buzzer will beep once every 4 seconds. When the battery voltage drops to the alarm level, the buzzer will beep once per second, and the UPS will soon automatically shut down. At this time, users could switch off any non-critical loads to disable the shutdown alarm and prolong the backup time. If no more load can be removed at this time, then all loads should be shut down as soon as possible to protect the devices or to save data. Otherwise, there is a risk of data loss or load failure.
- 2) In Battery mode, if the buzzer sounds annoying, the user can enter “Control ->Mute” on the LCD to silence it. Please refer to the section on “LCD operation”.
- 3) The backup time of the long-run model depends on the external battery capacity.
- 4) The backup time may change under different environment temperature and load type.
- 5) The maximum backup time is limited by default to 16.5 hours. After discharging for 16.5 hours the UPS will automatically shut down to protect the battery. The default time can be modified through the LCD panel or the communication port.

3-5-6. Test the batteries

- 1) To check the battery status or the performance when the UPS is running in Line / Converter mode, enter “Control -> Batt Test” to instruct the UPS to perform a battery test. Please refer to the section on “LCD operation”.
- 2) The UPS can also be instructed to perform a battery test through monitoring software.
- 3) If the UPS is in battery testing, “Battery test mode” will be displayed on the LCD, the buzzer indication will be the same as in battery mode, but both the line LED and the battery LED will be lit.

3-5-7. Turn off the UPS with utility power supply in Line mode

- 1) With the LCD on the home page, press the “OFF/ESC” button. The LCD will show a prompt page of “Turn Off”. Move the arrow to “Yes” using the up or down button, then press “ON/ENTER”. The UPS will turn off and go to bypass mode with beeping once. Alternatively, to turn off the UPS the user can enter the “control menu” and select the instruction “Turn Off”. Please refer to the section on “LCD operation”.

NOTE: Here, “Turn Off” means that the UPS is not operating in Line / Converter / Battery / Battery testing mode. Even though the UPS is turned off, if the input or bypass voltage is normal, the internal power supply will continue to operate; and if the bypass status has been set to “enable”, the output voltage of the UPS will continue to be present.

- 2) To fully turn off the output, switch off the external input breaker. A few seconds later the LCD display will turn off and the UPS will completely shut down.

3-5-8. Turn off the UPS without utility power supply in Battery mode

- 1) With the LCD on the home page, press the “OFF/ESC” button. The LCD will show a prompt page of “Turn Off”. Move the arrow to “Yes” using the up or down button, then press “ON/ENTER”. The UPS will turn off and go to bypass mode with beeping once. Alternatively, to turn off the UPS the user can enter the “control menu” and select the instruction “Turn Off”. Please refer to the section on “LCD operation”.
- 2) If there is no bypass input voltage, the UPS will shut down its internal power supply and the front panel display will turn off.

3-6. LCD Operation

The entire LCD structure is demonstrated in the diagram below:

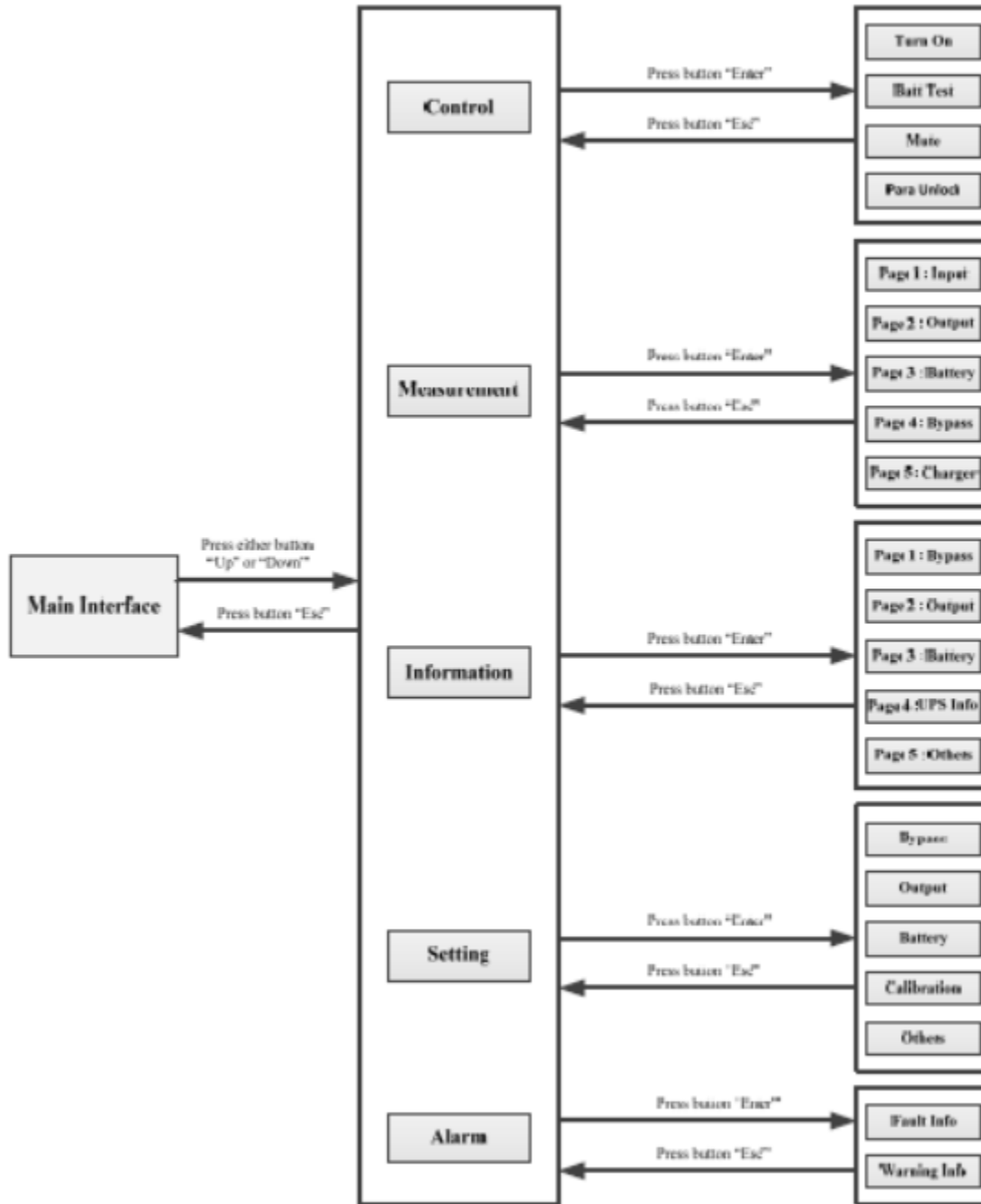

3-6-1 . Main interface (home page)

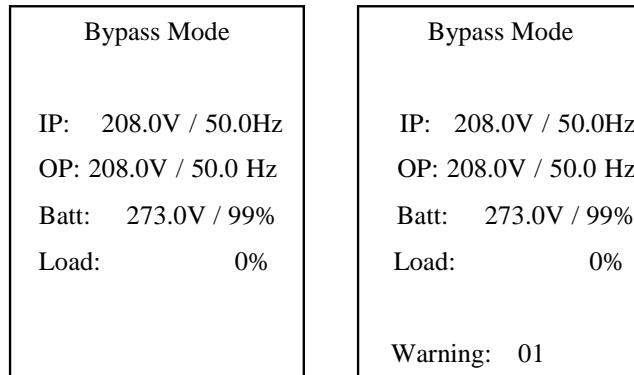

- 1) In the first line the LCD will display the UPS running status mode;
- 2) When alarms occur, the warning or fault information will be displayed below the “Load” line;
- 3) When the front panel is not operated for 10 minutes, the display page will return back to the home page;
- 4) Press the “UP” or “DOWN” button to enter the operation menu (see 3-7-2-1);
- 5) When the LCD displays the home page and if the UPS is in bypass, press “ON/ENTER” button to turn on the UPS to AC / converter / battery mode according to the setting and input status, or press “OFF/ESC” to allow the UPS to bypass mode or shut down. (refer to section on “Single UPS Operation”).

3-6-2. Operation menu

3-6-2-1. Main menu

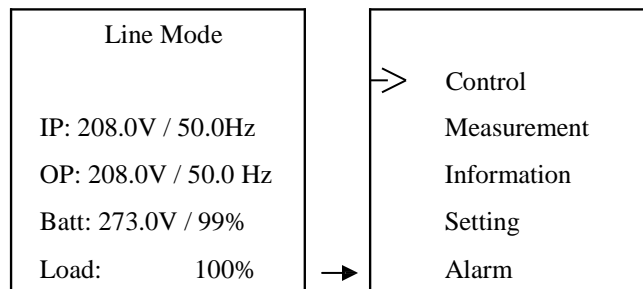

- 1) After pressing the “UP” or “DOWN” button at the home page the LCD will display five items in the operation Menu: Control / Measurement / Information / Setting / Alarm.
- 2) Press “UP” or “DOWN” button to select item;
- 3) Press “ON/ENTER” button to confirm the selection;
- 4) Press “OFF / ESC” button to return back to the home page;

3-6-2-2. Control

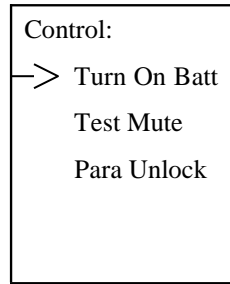

NOTE 1: “Para Unlock” appears only when a parallel communication failure occurs.

NOTE 2: “Turn On” will be displayed if UPS is not turned on. “Turn Off” will be displayed if UPS is turned on. Generally speaking, these two messages will not be displayed at the same time or in all operation modes.

1) Turn On/Turn Off

This item is for turning on/off the UPS;

- a) In Bypass mode the LCD will display “Turn On” in the control menu. If it is selected and confirmed, the UPS will transfer to AC mode or to converter mode or to battery mode according to the setting and input status.

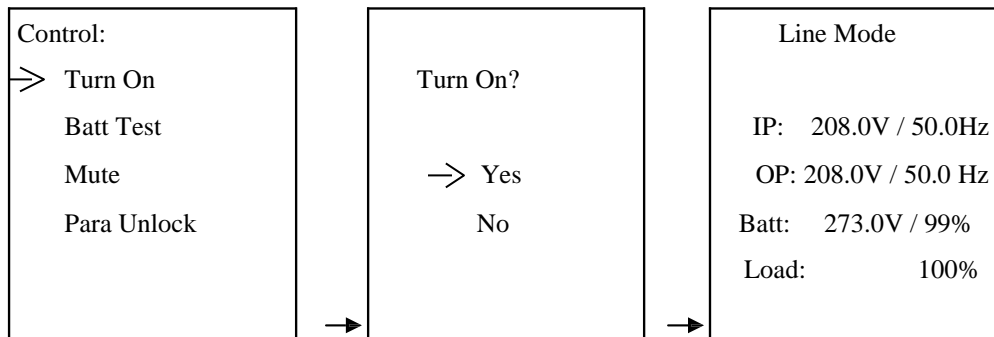

NOTE: The UPS may be turned on by simply pressing the “ON/ENTER” button in the home page. It’s not necessary to enter the control menu to turn on the UPS.

- b) In AC mode or converter mode or battery mode, the LCD will display “Turn Off” in the control menu. If it is selected and confirmed, the UPS will transfer to bypass mode or shut down.

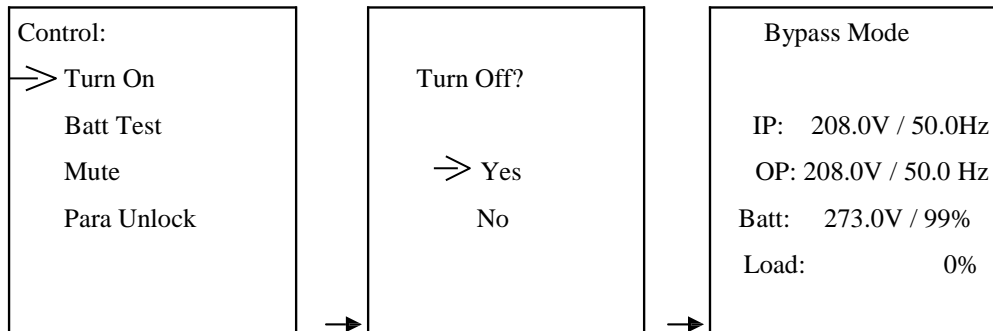

NOTE: The UPS may be turned off by simply pressing the “OFF/ESC” button in the home page. It’s not necessary to enter the control menu to turn off the UPS.

2) Battery Test

This item will test the performance of the battery. This item will be displayed under all UPS modes. However, the battery test cannot be executed if the UPS is in Battery/Fault mode (a reminder will pop up in the screen). When the battery test is selected, the screen will return back to the home page with “Battery Test Mode” displayed on the top line. If the test is completed, the displayed status will change back to the current mode of the UPS.

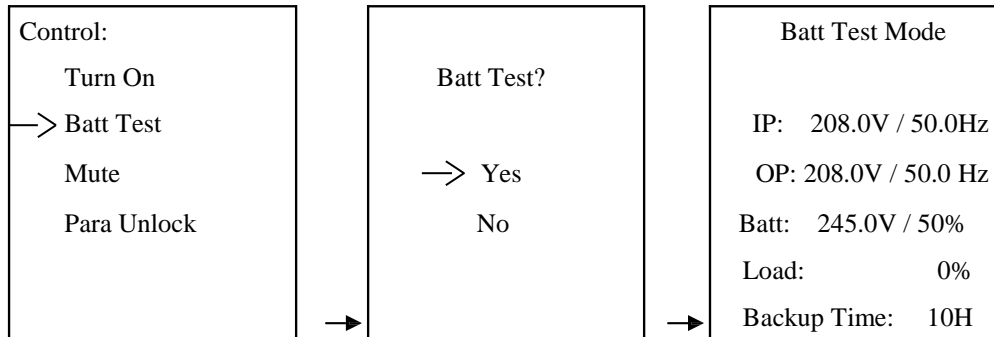

3) Mute

This item will mute the buzzer. This item will be displayed under all UPS modes. However, the buzzer can be muted only when the UPS is in battery/bypass/fault mode (a reminder will pop up in the screen). After the selection is confirmed, the display will return back to the home page and the mute icon will be displayed.

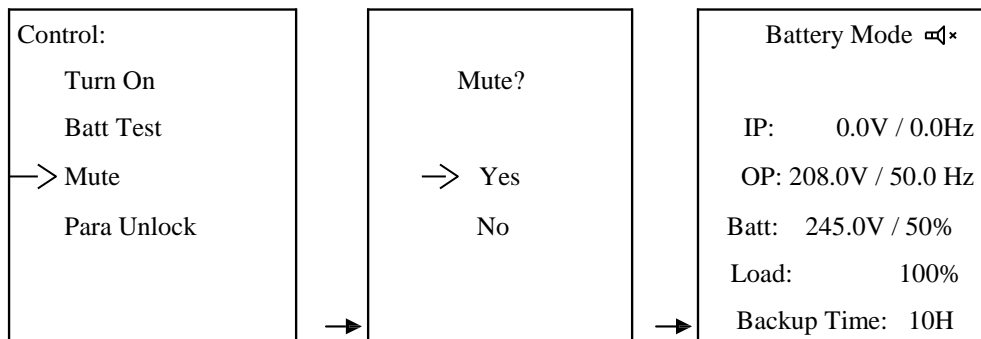

4) Para Unlock (part numbers with parallel option only)

This item allows the UPS to startup with parallel function and only appears when the LCD shows the warning of “3F: Para Protect”. The warning means that the parallel system is in protection and could not startup because of parallel communication failure. Before the parallel system is restarted, please confirm this selection first.

NOTE: Before executing this action, please check that the system cables and connections are connected correctly and safely. Please read the related contents in the section under troubleshooting.

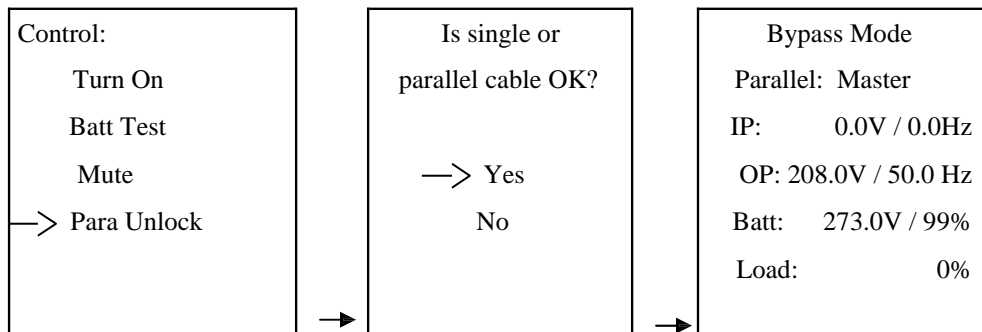

3-6-2-3. Measurement

Measurement displays the measured value of the parameters such as voltage / current / frequency / power / capacity / time etc. Press the “UP” or “DOWN” button to explore the pages.

Input:	1/5
Volt:	220.0V
Freq:	50.0Hz

Output:	2/5
Volt:	208.0V
Curr:	43.3A
Freq:	50.0Hz
Inv:	208.0V
Apparent Power:	6000VA
Active Power:	5400W
Load:	100%

Battery:	3/5
Volt:	273.0V
Cap:	100%
Dischg Time:	00: 00: 00

Bypass:	4/5
Volt:	220.0V
Freq:	50.0Hz

Charger:	5/5
Volt:	273.0V
Status:	On

3-6-2-4. Information

Information displays the value and status of all parameter settings. Press the “UP” or “DOWN” button to explore the pages.

Bypass: 1/6 Status: Open Enable HighLoss V: 264V LowLoss V: 110V HighLoss F: 54Hz LowLoss F: 46Hz	ECO: 2/6 Status: Open HighLoss V: 232V LowLoss V: 184V HighLoss F: 52Hz LowLoss F: 48Hz	Output: 3/6 Volt: 208V Freq: Auto CVCF: Disable
---	--	--

Battery : 4/6 Backup Time : 990 Minute Batt Test Type : Short Time : 10 Second	UPS Info : 5/6 UPS Model : XXXX DSP Ver : XXXX MCU Ver : XXXX Unit Name : XXXXXXXXXXXX Manufacturer : XXXXXXXXXXXX	Others : 6/6 Hot Standby : Disable Bypass Mute : Disable Batt Mute : Disable Fault Mute : Disable
--	---	---

3-7-2-5 . Setting

This menu is used to configure the parameter settings or to do the calibrations.

Setting : Bypass → Output Battery Calibration Others
--

NOTE: Some settings will only be available in certain operation modes. If the setting is not available in the current Mode, the LCD will show the message “Item cannot be set in this mode”. Press any button or wait several seconds for the message to disappear.

1) Bypass setting

Interface	Description
<div style="border: 1px solid black; padding: 5px; margin-bottom: 10px;"> <p>Bypass :</p> <p>Status : Open</p> <p> Enable</p> <p>HighLoss V : 264V</p> <p>LowLoss V : 110V</p> <p>HighLoss F : 54Hz</p> <p>LowLoss F : 46Hz</p> </div> <div style="border: 1px solid black; padding: 5px;"> <p>Bypass :</p> <p>Status : Forbid</p> <p>HighLoss V : 264V</p> <p>LowLoss V : 110V</p> <p>HighLoss F : 54Hz</p> <p>LowLoss F : 46Hz</p> </div>	<p>1. Status (only available in bypass / AC mode)</p> <p>1.1 Open / Forbid :</p> <p>Open : Bypass allowed. When selected, UPS will run in Bypass mode depending on bypass enabled/disabled setting.</p> <p>Forbid : Bypass not allowed. When selected Bypass mode is not allowed under any situation.</p> <p>1.2 Enable / Disable :</p> <p>This option appears only when Bypass status is set to “Open”. Enable : Bypass enabled. When selected, Bypass mode is activated. Disable : Bypass disabled. When selected, automatic bypass is acceptable, but “manual bypass” is not available. “Manual bypass” means the user manually puts the UPS into Bypass mode (for example, in AC mode turning off the UPS will put the UPS into Bypass mode). Then, the UPS will go to bypass mode but with no output if it is turned off in AC mode.</p> <p>NOTE : The following items are only available in bypass mode :</p> <p>2. HighLoss V : Set the acceptable high voltage for bypass. Setting range is from (rated Output Volt + 11V) to 276V. The default value is 264V.</p> <p>3. LowLoss V : Set the acceptable low voltage for bypass. Setting range is from 110V to (rated Output Volt - 11V). The default value is 110V.</p> <p>4. HighLoss F: Set the acceptable high frequency for bypass.</p> <p>50 Hz system : Setting range is from 51.0 Hz to 54.0 Hz.</p> <p>60 Hz system : Setting range is from 61.0 Hz to 64.0 Hz.</p> <p>The default value is 54.0 Hz / 64.0 Hz.</p> <p>5. LowLoss F: Set the acceptable low frequency for bypass.</p> <p>50 Hz system : Setting range is from 46.0 Hz to 49.0 Hz.</p> <p>60 Hz system : Setting range is from 56.0 Hz to 59.0 Hz.</p> <p>The default value is 46.0 Hz / 56.0 Hz.</p>

2) **Output setting** (only available or effective on bypass mode)

Interface	Description
<div style="border: 1px solid black; padding: 10px; margin: 10px;"> <p>Output :</p> <p>→ Volt : 208V</p> <p> Freq : 50Hz</p> <p> CVCF : Enable</p> </div>	<p>1. Volt :</p> <p>200 : Sets the output voltage to 200Vac</p> <p>208 : Sets the output voltage to 208Vac</p> <p>220 : Sets the output voltage to 220Vac</p> <p>230 : Sets the output voltage to 230Vac</p> <p>240 : Sets the output voltage to 240Vac</p> <p>2. Freq :</p> <p>50Hz : Sets the output frequency to 50Hz.</p> <p>60Hz : Sets the output frequency to 60Hz.</p> <p>ATO : If selected the output frequency will be decided according to the latest normal utility frequency. If the utility frequency is in the range 46Hz to 54Hz, then the output frequency will be 50Hz. If the utility frequency is in the range 56Hz to 64Hz, the output frequency will be 60Hz. ATO is the default setting.</p> <p>3. CVCF :</p> <p>Enable or disable converter mode.</p> <p>Enable : The output frequency will be fixed at 50Hz or 60Hz according to setting of “Freq”. The input frequency can be anywhere in the range 46Hz to 64Hz.</p> <p>Disable : The output frequency will synchronize with the input frequency within 46 ~ 54Hz for a 50Hz system or within 56 ~ 64Hz for a 60Hz system.</p> <p>NOTE : CVCF means Constant Voltage and Constant Frequency and represents converter mode.</p>

3) **Battery setting** (available in all operational modes)

Interface	Description
<p>Battery :</p> <p>→ DisChg Protect :</p> <p style="padding-left: 40px;">Enable</p> <p style="padding-left: 40px;">990 Minute</p> <p>Batt Test Type :</p> <p style="padding-left: 40px;">Short Time :</p> <p style="padding-left: 40px;">Till Batt Low</p>	<p>1. Dischg Protect :</p> <p>1.1</p> <p>Enable : Battery discharge protection function is enabled. When the UPS has been continuously operating in “battery/battery test mode”, the UPS will automatically shut down when the discharge time set by option 1.2 below has expired.</p> <p>Disable : Battery discharge protection function is disabled.</p> <p>1.2</p> <p>0000 ~ 1500 : The maximum discharge time ranging from 0 to 1500 minutes. When “Dischg Protect” is enabled the UPS will shut down to protect the battery after backup time arrives. If “Dischg protect” is disabled then this setting is not functional. The default value for this setting is 990 minutes.</p> <p>2. Batt Test Type :</p> <p>2.1 Short Time : Battery test will last for a duration of 10 seconds.</p> <p>2.2 Long Time : The duration of the battery test can be set to 01 ~ 99 minutes.</p> <p>2.3 Till Batt Low : Battery test will not stop until the battery voltage is low.</p>
<p>Battery :</p> <p>→ DisChg Protect :</p> <p style="padding-left: 40px;">Enable</p> <p style="padding-left: 40px;">990 Minute</p> <p>Batt Test Type :</p> <p style="padding-left: 40px;">Short Time :</p> <p style="padding-left: 40px;">10 Minute</p>	
<p>Battery :</p> <p>→ DisChg Protect :</p> <p style="padding-left: 40px;">Enable</p> <p style="padding-left: 40px;">990 Minute</p> <p>Batt Test Type :</p> <p style="padding-left: 40px;">Short Time :</p> <p style="padding-left: 40px;">10 Second</p>	

4) Calibration (for authorized service personnel only)

Interface	Description
<div style="border: 1px solid black; padding: 5px; margin-bottom: 10px;"> <p>Calibration :</p> <p>→ Batt: 273.0 +0.0</p> <p>Inv: 209.0 +0.0</p> <p>Chg: 273.0 +0.0</p> </div>	<p>1. Batt: Calibrate the battery voltage measurement. Calibration range is from 0V to 5.7V. The default value is 0V. Battery calibration is available in all operational modes.</p> <p>2. Inv: Adjust the inverter output voltage. The adjustable range is from 0V to 6.4V. The default value is 0V. Inverter calibration is only available in line/battery/converter mode.</p> <p>3. Chg: Adjust the Charger output voltage. The adjustable range is from 0V to 6.9V. The default value is 0V. Charger calibration is only available in bypass/line/converter mode.</p> <p>NOTE: Before making any charger output voltage adjustment, first disconnect all batteries to obtain an accurate charger voltage. The adjustment should be suitable to the battery specifications, or the battery may be destroyed.</p>

5) Others

Interface	Description
<div style="border: 1px solid black; padding: 5px; margin-bottom: 10px;"> <p>Others :</p> <p>→Hot Standby Backup Time</p> </div> <div style="text-align: center; margin-bottom: 5px;">↓</div> <div style="border: 1px solid black; padding: 5px;"> <p>Hot Standby :</p> <p>→Status : Disable</p> </div>	<p>Hot standby :</p> <p>Enable : Hot standby function is enabled. This means that the UPS is set to be a host of a hot standby system and that the UPS will automatically restart after AC recovery even without a battery connected.</p> <p>Disable : Hot standby function is disabled. The UPS is operating in normal mode and cannot restart without a battery. Disable is the default setting.</p>

Interface	Description
<div style="border: 1px solid black; padding: 10px; margin-bottom: 10px;"> <p>Others :</p> <p style="margin-left: 20px;">Hot Standby</p> <p style="margin-left: 20px;">→ Backup Time</p> </div> <div style="text-align: center; margin-bottom: 10px;">↓</div> <div style="border: 1px solid black; padding: 10px;"> <p>Backup Time :</p> <p style="margin-left: 20px;">→</p> <p style="margin-left: 40px;">Batt Groups : 1</p> <p style="margin-left: 40px;">Batt Cap : 9AH</p> <p style="margin-left: 40px;">Factor : 1.0</p> </div>	<p>Backup Time Parameter Setting : (Authorized Installation Personnel Only)</p> <p>Batt Groups : Set the number of battery groups ranging from 1 to 6. The default value is 1 group.</p> <p>Batt Cap : Set the battery capacity such as 7AH, 9AH, 10AH, 12AH, 17AH, 26AH, 40AH, 65AH, 100AH and so on. The default value is 9AH.</p> <p>Factor : Calibrate the displayed backup time by adjusting this multiplier factor. The formulation is listed below :</p> <p>Displayed backup time = Original backup time X Multiplier factor</p> <p>The value of the default factor is 1.0 and can range from 0.5 to 2.</p> <p>These parameters are for the battery backup time calculation.</p>

3-7-2-6 . Alarm page

Alarm Info
<p>Fault :</p> <p style="margin-left: 20px;">14 : Output Short</p> <p>Warning :</p> <p style="margin-left: 20px;">01 : Bat Open</p>

This page records and displays the faults and warning events as they occurred in time.

4. INTERFACES

The UPS is equipped with a serial interface COM 3, USB and an interface slot COM. These interfaces can be used for :

1. Direct communication between UPS and a workstation/server.
2. Integration of the UPS as client into a network with centralized monitoring via a Manage UPSNET SNMP adaptor in the slot COM.
3. Transfer of operational states to external alarm systems via voltage-free contacts.

The necessary communication software packages and interface cables are available as options.

4-1. Serial Interface COM 3

The 9-pole SUB-D connector (pin contacts) contains RS232 compatible signals. Refer to Figure 11 on page 13.

NOTE: The interface COM RS232 is electrically isolated from primary UPS circuits.

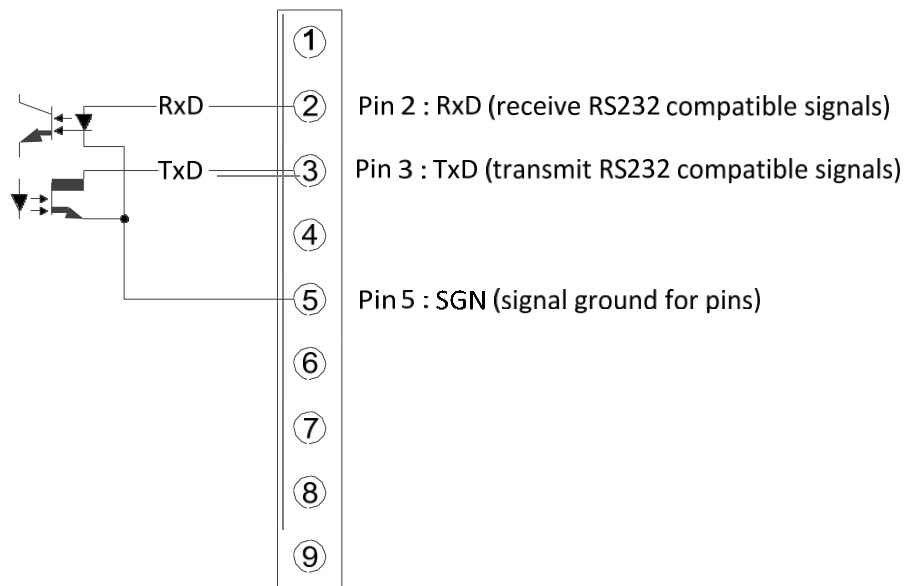

Figure 14 : Serial Interface COM3

4-2. Interface Slot COM

The interface slot COM can be fitted with various optional interface cards. Interface cards include:

- SNMP adaptor (Manage UPSNET) for connecting the device to a network
- isolated contacts card

Refer to the installation guide supplied with the optional interface card.

5.0 Emergency Power Off (EPO)

The external connection to the EPO circuit is located just above the USB connector in the upper rear of the unit. If the circuit between the two EPO connector pins is “opened” the output of the UPS is immediately switched off. To restart the UPS, the procedures outlined in the section “Single UPS Operation” must be followed. The EPO circuit may be extended by connecting the “normally closed” switches in series between the EPO connector pins. Activating (opening) any of the series switches will cause the UPS to shut off its output.

6. Maintenance

6.1 Maintenance Warnings



- Service and repair should only be done by trained authorized personnel. During any service work to the UPS, it should be turned off or manually bypassed. Note that potentially lethal voltages exist within this unit as long as the battery supply is connected.
- Your UPS power module and battery module(s) do not require routine maintenance. Do not open them for any reason. There are no user-serviceable parts inside.
- Even after the unit is disconnected from the mains, components inside the UPS system are still connected to the battery packs which are potentially dangerous.
- Before carrying out any kind of service and/or maintenance, disconnect the batteries and verify that no current is present, and no hazardous voltage exists on the terminals of high capacity capacitors such as BUS-capacitors.
- Fuses should be replaced only by factory authorized personnel. Blown fuses should be replaced only with fuses of the same number and type.
- Verify that no voltage between the battery terminals and the ground terminal is present before maintenance or repair. In this product, the battery circuit is not isolated from the input voltage. Hazardous voltages may occur between the battery terminals and the ground terminal.

6.2 Test, Replacement and Disposal of Batteries

The UPS does not require maintenance by the user, however, battery maintenance is recommended in accordance with IEEE Recommended Practice for Maintenance, Testing and Replacement of Valve-Regulated Lead-Acid (VRLA) Batteries for Stationary Applications (IEEE Std 1188-1996). When the batteries expire, trained battery service personnel must replace them. A certified disposal/recycling company should carry out disposal / recycling of the UPS and / or batteries. Exhausted rechargeable batteries are classified as “harmful toxic waste” and as such the law demands that they be disposed of / recycled by an authorized recycling center.

The manufacturer’s service center is fully equipped to deal with such batteries, in accordance with the law and with the greatest respect for the environment. Contact Technical Support to arrange for maintenance and/or battery replacement.

The typical battery life cycle is 3 to 5 years, at an ambient temperature of 77°F (25°C), however battery life is also dependent on the frequency and duration of mains failures or battery discharge cycles.

The battery test should be carried out periodically (6 to 12 months) in order to ascertain the general condition of the batteries.

6-2-1. Battery Replacement



WARNING: Prior to starting the battery replacement, please read the entire instructions for important safety procedures.

NOTE: To obtain new battery(ies), contact SURGEX Technical Services at 847-596-7000, toll free at 800-369-7179.

NOTE: The UPS cannot protect against power outages while the batteries are disconnected.

**WARNING:**

- External batteries cannot be replaced during “normal operation” of the UPS. The UPS devices have no internal battery.
- Servicing of batteries should be performed or supervised by personnel knowledgeable about batteries and the required precautions.
- The batteries installed in the UPS and in the external battery cabinets contain electrolyte. Under normal conditions the containers are dry. A damaged battery may leak electrolyte that can be dangerous in contact with the skin and cause irritation to the eyes. Should this happen, wash the affected part with copious amounts of water and seek immediate medical attention.
- When replacing batteries, replace with the same type and number of batteries or battery packs.
- Do not dispose of batteries in a fire. The batteries may explode. Dispose of used batteries according to the instructions
- Do not open or damage the battery cases. Released electrolyte is harmful to the skin and eyes and may be toxic.
- A battery can present a risk of electrical shock and high short-circuit current. The following precautions should be observed when working on batteries:
 - Remove watches, rings or other metal objects
 - Use tools with insulated handles
 - Wear rubber gloves and boots
- Do not short or bridge the battery terminals with any object.
- Unplug and turn off the UPS before performing battery replacement.
- Do not connect or disconnect the battery module(s) while the UPS is operating from the battery supply.
- Do not lay tools or metal parts on top of batteries
- Disconnect charging source prior to connecting or disconnecting battery terminals
- Determine if the battery is inadvertently grounded. If inadvertently grounded, remove source from the ground. Contact with any part of a grounded battery can result in electrical shock. The likelihood of such shock can be reduced if such grounds are removed during installation and maintenance (applicable to equipment and remote battery supplies not having a grounded supply circuit).

6-3 Storage

For extended storage at ambient temperature $<25^{\circ}\text{C}$ ($<77^{\circ}\text{F}$) the batteries should be charged for 5 hours once every 4 months, at higher storage temperatures it is advised that this period be reduced to 2 months.

1. Connect the UPS (with attached external battery cabinets) to a mains outlet socket having an earth connection or install fixed connections (in accordance with chapter "Installation" on page 7) to an appropriate source.
2. Switch on the input miniature circuit breaker at the rear of the devices (UPS and external battery cabinet) in the case of fixed connections.
3. After 5 hours, unplug from the mains supply or switch off the input miniature circuit breaker of the UPS in case of fixed connections and switch off the circuit breaker of the external battery cabinet.
4. Remove the UPS and external battery cabinet connections in the opposite sequence to that described in "Installation".
5. Note the date recharging was carried out on the packaging of the external battery cabinet.

6-4. Cleaning

NOTE: Do not use scouring powder or plastic-dissolving solutions to clean the UPS.

1. Switch off the UPS by pressing the OFF button following the shutdown procedure and disconnect from the mains supply.
2. Make sure that the air vents on the UPS are not obstructed.
3. Remove dust from the air vents with a vacuum cleaner.
4. Clean the outside of the UPS housing by wiping with a dry or a slightly damp cloth.

NOTE: Do not allow liquid to get inside the UPS.

7. Troubleshooting

7-1. Warning status

When the Fault LED flashes and the buzzer beeps once every second this means that there is a problem(s) with the UPS. In this case the LCD will display a warning code(s) which the user can use to trouble shoot the UPS by referring to the troubleshooting table below for the possible cause of the problem.

7-2. Fault mode

- 1) When the fault LED illuminates and the buzzer beeps continuously this means that there is a fatal error in the UPS. In this case the LCD will display a fault code(s) which the user can use to trouble shoot the UPS by referring to the troubleshooting table below for the possible cause of the fault.
- 2) Do not attempt to turn on the UPS before the problem has been corrected. If the problem cannot be corrected, please contact the distributor or service personnel immediately.
- 3) In an emergency, immediately disconnect the UPS from the connection to the utility, external battery, and output to avoid more risk or danger.

7-3. Troubleshooting table

Refer to the table below for troubleshooting the UPS.

Alarm type	LCD display	Possible cause	Remedy
Warning	01 : Batt Open	<ol style="list-style-type: none"> 1) The battery is not connected. 2) The battery protection device is open. 	<ol style="list-style-type: none"> 1) Connect the battery. 2) Replace or restore the protection device.
Warning	07 : Over Charge	<ol style="list-style-type: none"> 1) Battery numbers and setting do not match 2) Charger voltage is too high or charger failure. 	<ol style="list-style-type: none"> 1) Correct the battery number or it's setting. 2) Disconnect the battery and check the charger output voltage. Contact the dealer to repair.
Warning	08 : Batt Low	<ol style="list-style-type: none"> 1) Battery is discharged deeply to low level. 2) Battery number is not correct. 3) Battery is at the end of life. 	<ol style="list-style-type: none"> 1) Recharge the battery. 2) Correct the battery number. 3) Replace the battery.
Warning	09 : Over load	The load exceeds the rating of the UPS.	Remove excess loads from the UPS.
Warning	0A : Fan Error	<ol style="list-style-type: none"> 1) Fan is blocked. 2) Fan is at the end of life. 3) Fan detection circuit has failed. 	<ol style="list-style-type: none"> 1) Make sure the fan is not blocked. 2) Contact the dealer to replace the fan. 3) Contact the dealer to repair.

Alarm type	LCD display	Possible cause	Remedy
Warning	0B : EPO Enable	EPO plug (jumper) is removed or the external EPO switch is off.	Connect the EPO plug (jumper) or switch on the external EPO switch.
Warning	0D : Over Temp	The internal temperature is too high. 1) environment may be too hot. 2) fan may be blocked or has failed. 3) ventilation may be blocked by the wall or other objects. 4) the UPS is overloaded.	1) Do not allow the ambient temperature to exceed 40°C. 2) confirm that the fan is not blocked and is operating normally. 3) confirm that there is good ventilation. 4) remove the overload.
Warning	0E : Charger Fail	The charger has failed.	Contact the dealer to repair.
Warning	10 : IP Fuse Open	The input fuse on the power stage board is open.	Check the input fuse and replace the fuse if it is open.
Warning	33 : Overload 3 Times	The UPS is locked in bypass after an overload has occurred three times in 30 minutes.	Remove the overload, shut down the UPS and restart it.
Warning	3A : Maintain Open	EMBS port is open or the maintain switch sensor (connected to EMBS port) is triggered. (The UPS is transferred to bypass).	If the EMBS port is short-circuited, the warning will disappear.
Warning	3F : Para Protect	Parallel cable is not connected well when restart after the parallel system is fault because of parallel communication failure. (When this warning appeared, the UPS could not start up because it is system protection for parallel system.	1) Confirm that the parallel cable is securely connected. Choose “Para Unlock” from the control menu to remove the warning and then the UPS will start up. 2) If the UPSs in the system are separated to single UPS, disconnect the output to other UPSs and choose “Para Unlock” in control menu to remove the warning. Then, the UPS can start up.

Alarm type	LCD display	Possible cause	Remedy
Warning	3F : Para Protect		NOTE : Check the UPS operational mode (parallel or single) and the connections. The UPS may be damaged if the parallel cable is not securely connected while the UPS is in the parallel mode.
Fault	01 : Bus Start Fail	The internal converter failed so that the DC bus voltage could not be boosted to the correct level.	Contact the dealer to repair.
Fault	02 : Bus Over	1) DC bus voltage is too high because of mains input or load transient current. 2) The internal converter failed.	1) Shut down and restart the system and observe if the fault reoccurs. 2) Contact the dealer for repair.
Fault	03 : Bus Under	The internal converter failed so that the DC bus voltage is too low.	Contact the dealer to repair.
Fault	04 : Bus Unbalance	1) The load is abnormal so that the internal positive and negative DC bus voltages are unbalanced. 2) The internal converter failed.	Contact the dealer.
Fault	11 : Inv Start Fail	The internal inverter failed so that the inverter voltage could not start up correctly.	Contact the dealer to repair.
Fault	12 : Inv Volt High	The internal inverter failed so that the inverter voltage is too high.	Contact the dealer to repair.
Fault	13 : Inv Volt Low	The internal inverter failed so that the inverter voltage is too low.	Contact the dealer to repair.
Fault	14 : Output Short	Short circuit occurs on the UPS output.	Remove the short circuit.

Alarm type	LCD display	Possible cause	Remedy
Fault	1A : NegPower	UPS output power is negative. There is energy feedback into the UPS from the output. This may be caused by regenerative load or current control failure in the parallel system.	Contact the dealer.
Fault	21 : Batt SCR Short	The internal battery SCR has failed short.	Contact the dealer to repair.
Fault	24 : Inv Rly Short	The internal inverter relay is permanently shorted or the SCR of the STS (Static Transfer Switch) is shorted.	Contact the dealer to repair.
Fault	35 : Para Comm Fail	Parallel cable for communication is not securely connected in the parallel system.	Securely connect the parallel cable.
Fault	36 : OP.I Unbalance	The output current is extremely unbalanced between the parallel UPSs or there is an error in the parallel system.	Contact the dealer to repair.
Fault	41 : Over Temp	The internal temperature is too high and has reached the fault level (shutdown) : 1) environment may be too hot. 2) fan may be blocked or has failed. 3) ventilation may be blocked by the wall or other objects. 4) the UPS is overloaded.	1) Do not allow the ambient temperature to exceed 40°C. 2) confirm that the fan is not blocked and is operating normally. 3) confirm that there is good ventilation. 4) remove the overload.
Fault	42 : CPU Comm Fail	Internal communication failure between CPUs.	Contact the dealer to repair.
Fault	43 : Over load	Duration of overload is outside the specification and the UPS shuts down automatically.	Remove excess loads from the UPS output and restart the UPS.

9. APPENDIX A : SPECIFICATIONS

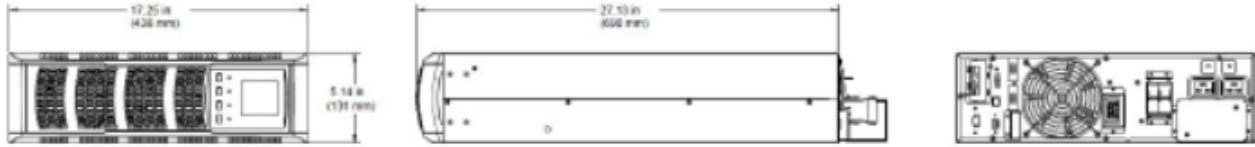

Model Part Number	UPS-17602-52R
Type	Sinergy III
Power Rating	6000 VA / 5400 W
Topology	On-Line Double Conversion
Heat Dissipation (BTU/Hour)	3511 at 100% Load
Input Voltage (Nominal) Range	200 / 208 / 220 / 230 / 240 VAC (Selectable) 176-300 VAC
Input Frequency	50/60 Hz \pm 4 (Auto Sense on Start-Up)
Input Power Factor	>0.95
Input Current THD	<9.0%
Efficiency	>84.0%
Output Voltage	208 VAC (Default) 200 / 220 / 230 / 240 VAC (Selectable)
Output Current	28.8 A (Default) 30.0 / 27.3 / 26.1 / 25.0 A (Selectable)
Voltage Regulation	\pm 1.0%
Overload Online Mode	100-110%: 10 Minutes 110-130%: 1 Minute >130%: 1 Second
Overload Battery Mode	100-110%: 30 Seconds 110-130%: 10 Seconds >130%: 1 Second
Overload Bypass Mode	100-130%: Continue to Carry Load >130%: Load Shut Down After 1 Minute
Battery Voltage (Float / Nominal)	274.0 / 240.0 VDC
Charger Current	1.0 A
Backup Time (Full Load)	<7.0 Minutes
Communications Interface	USB / RS-232
Shipping Weight	59.0 Pounds / 26.8 Kilograms

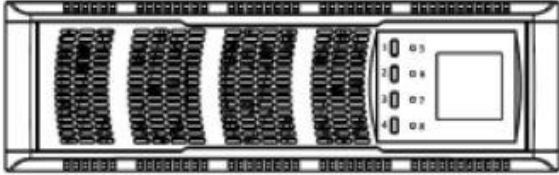
<p>Front Panel Controls</p>  <table border="0"> <tr> <td>1. OFF / ESC</td> <td>5. BYPASS LED</td> </tr> <tr> <td>2. UP (MENU)</td> <td>6. LINE LED</td> </tr> <tr> <td>3. DOWN (MENU)</td> <td>7. BATTERY LED</td> </tr> <tr> <td>4. ON / ENTER</td> <td>8. FAULT</td> </tr> </table> <p>Rear Panel Information and Controls</p> <ul style="list-style-type: none"> • Hardwire Input Connection (Screw Terminal) • Hardwire Output Connection (Screw Terminal) • USB & RS-232 Communication • SNMP Adapter (Optional) • Internal Relay Contact Card (Optional) • Circuit Breaker <p>External Batteries (Single Battery Cabinet)</p> <ul style="list-style-type: none"> • Type - 12 V, 9.0 AH • Quantity - 20 Batteries • Recharge time - 9 hours to 80%, 24 hours to 100% (1A Charger) 	1. OFF / ESC	5. BYPASS LED	2. UP (MENU)	6. LINE LED	3. DOWN (MENU)	7. BATTERY LED	4. ON / ENTER	8. FAULT	<p>Environmental</p> <ul style="list-style-type: none"> • Temperature: 0 - +40° C (32 - 104°F) Operating -20 - +50° C (-40 - +122° F) Shipment, Storage • Humidity: <90% Non-Condensing (Operating, Shipment, Storage) • Altitude: <1000m Operating, No De-Rating >1000m De-Rate Output 1% per 100m <p>Safety Agency and EMC Compliance: All units are listed by UL, and marked with the UL/cUL marking.</p> <p>Products Listed To:</p> <ul style="list-style-type: none"> • UL1778 • cUL to CSA22.2 No.107.1 <p>Products in compliance with:</p> <ul style="list-style-type: none"> • FCC Part 15J Class A • IEC61000-4-2, Electrostatic Discharge • IEC61000-4-3, Radiated Electromagnetic Field Immunity • IEC61000-4-4, Electrical Fast Transient / Burst Immunity • IEC61000-4-5, Surge Immunity • IEC61000-4-6, CS • IEC61000-4-8, Power Frequency Magnetic Field • IEC61000-2-2, Low Frequency Signal <p>RoHS Compliance: All products are RoHS compliant</p>
1. OFF / ESC	5. BYPASS LED								
2. UP (MENU)	6. LINE LED								
3. DOWN (MENU)	7. BATTERY LED								
4. ON / ENTER	8. FAULT								

	BATT CAB Part number	UPS-17888-62R
B A T T E R Y	Voltage (VDC)	240.0 nominal
	Battery	12V, 9 Ahr Flame Retardant, Sealed Lead-Acid
	Quantity	20
	Recharge Time	9 hours typical to 90% (Single Battery Cabinet, 1A charger)
M E C H A N I C A L	Length in (mm)	17.25 (438)
	Height in (mm)	5.14 (131) [3U height]
	Depth in (mm)	27.13 (690) [includes 2.75" (70mm) for battery connection cable]
	Unit Weight lbs. (kg)	142 (64.5)
	Shipping Weight lbs. (kg)	161 (73.2)

UPS-17888-62R Compatible External (Extended Run) Battery Cabinet:

Description: Extended Run Battery Cabinet (20 batteries)

UPS-17602-52R Typical run times with external battery cabinets

Percent Capacity	Watts	Number of Battery Cabinets							
		1	2	3	4	5	6	7	8
Runtimes are expressed in minutes Typical runtimes based on fully charged, new batteries, operating under typical load conditions Times estimated assuming a switch mode power supply Runtimes are affected by battery age, ambient temperature, site specific usage patterns and load conditions									
10	540	92	233	402	593	801	>16 hrs.	>16 hrs.	>16 hrs.
20	1080	46	118	204	301	406	519	639	765
30	1620	30	75	130	192	259	331	408	488
40	2160	21	54	93	137	185	237	291	349
50	2700	16	41	71	105	142	181	223	266
60	3240	13	33	57	84	113	145	178	213
70	3780	11	27	47	69	93	119	147	176
80	4320	9	23	40	58	79	101	124	149
90	4860	8	20	34	50	68	87	107	128
100	5400	7	17	30	44	59	76	93	112